



YUEN I



CARRIERS



KICKSTANDS



BOTTLE CAGES



ACCESSORIES



WORKSTANDS



STORAGES



INDOOR TRAINERS



METAL WORKING

2027

BUILDING TOMORROW

ESG
DESIGNED & BUILT
NEXT-GEN FACTORY



YUENI ESG REPORT 2026

2024-2025
Inventory Report

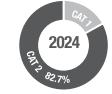

Total CO2 Emissions = 254.9 T GHG
(Purchased from Taipower)
CAT 1 = 17.3% Direct GHG Emissions 44.1T
CAT 2 = 82.7% Indirect GHG Emissions 210.8T

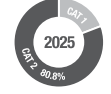

Total CO2 Emissions = 277.3 T
(Purchased from Taipower)
CAT 1 = 18.16% Direct GHG Emissions 53.2T
CAT 2 = 80.8% Indirect GHG Emissions 224.59T

SUSTAINABILITY GOAL & EFFORT TOWARDS 2030

**2030
ESG-SDG
GOAL**

**CO2 REDUCTION
GREENER ENERGY**

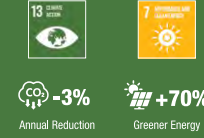

**LABOUR WELFARE
COMMUNITY SERVICE**



**GLOBAL ALLIANCES
RISK MANAGEMENT**



2027
2026

2027.07
ISO 14064
to request third-party verification and continue annually

2026.12
Solar Power Online
on new factory roof top to generate power to meet RE70

2026.06
New Factory Building
Operating License to obtain by County Government

2026.03
ISO 14064-1
Self-Audit Carbon Footprint Verification

2026.09
WRAP Audit
Worldwide Responsible Accredited Production to be completed

2026.06
Zero-Placement Fee Policy
officially implemented to align with International Standards for migrant workers and labour rights

2025

2025.12
Formulation of CFP-PCR Certification
for Taiwan Ministry of Environment for Kick stand category, code 25-020

2025.12
WRAP Signed up
Worldwide Responsible Accredited Production under due diligence and counselling

2025.12
C-TPAT Signed up
under due diligence and counselling

2024

2024
ISO 14067
Self-Audit Carbon Footprint Verification for Kick stand / Work Stand

2024.09/11
BAS Human Rights Code Of Conduct
signed and report produced for BAS Human Rights Risk Assessment

2024.01
BAS Membership Obtained
Bicycle Association for Sustainability

2023

2022-2024
ISO 14064-1
Self-Audit Carbon Footprint Verification completed 2023/1, 2024/1, 2025/1

2023.08
Social Service and Public Welfare Responsibility Agreement
signed with donation of a resource recycling vehicle given to local community.

2023.05
Labour Relations Consultant
stationed for consultation



YUENI

FROM YOUR IDEA TO REALITY
OUR PROFESSIONAL TEAM AT YOUR SERVICE

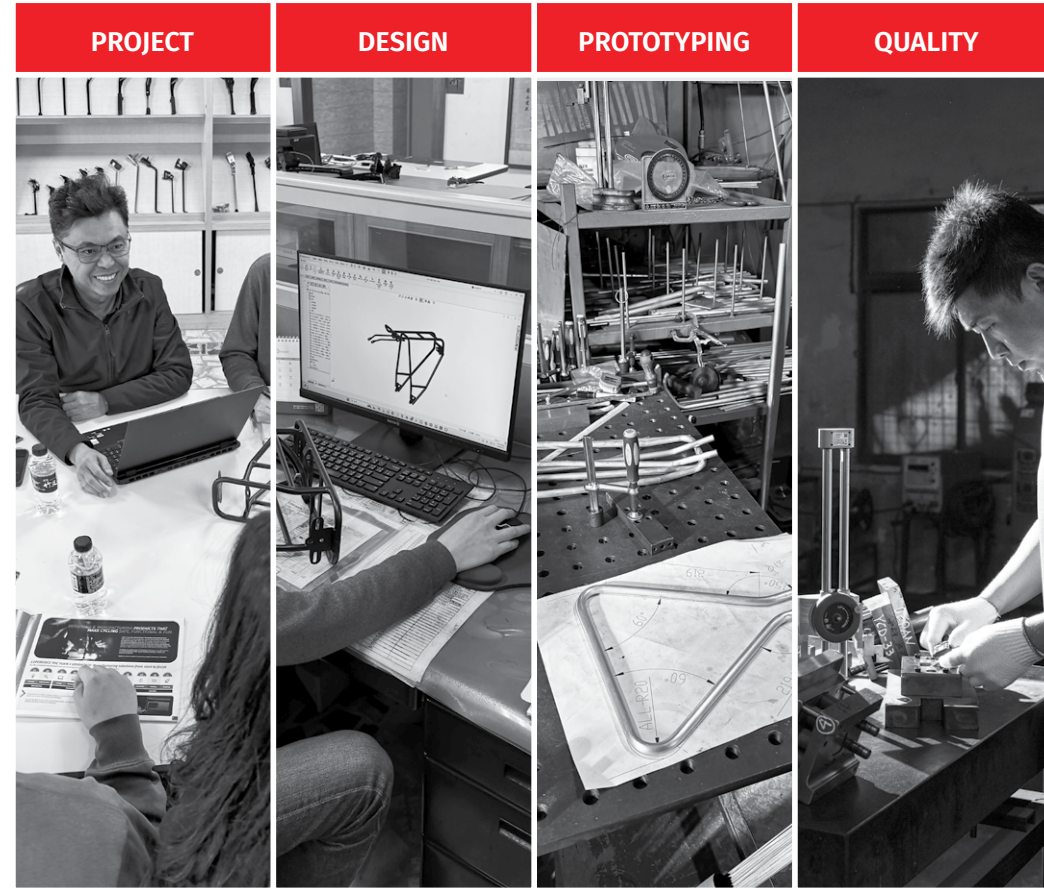

FROM MANUFACTURING TO TESTING
WE PROVIDE EXPERT SUPPORT TO ENSURE YOUR PRODUCTS SHELF READY

MATERIAL & FABRICATION TECHNIQUE



Tooling

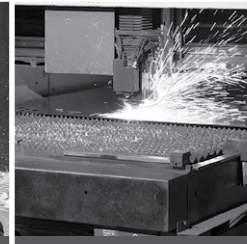

Laser Cutting

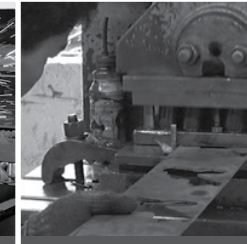

Stamping

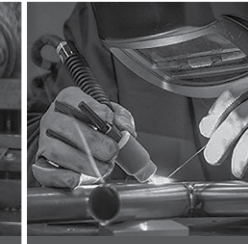

TIG



Die-casting

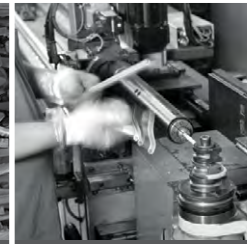

Tube Bending



Heat Treatment

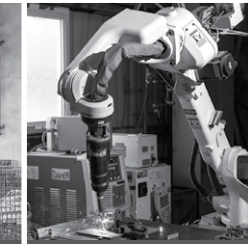

Robotic

ASSEMBLY

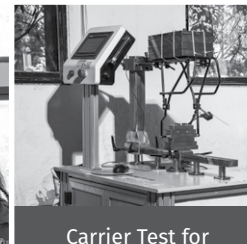

Carrier Test for ISO 11243



Kickstand Testing

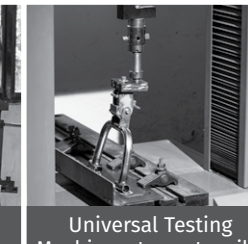

Universal Testing Machine: stress, tensile, deformation

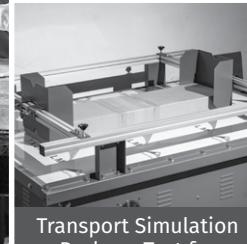

Salt Spray Test for NSS CASS



Hardness Test for HRC HRB HRA

**DESIGNING & MANUFACTURING PRODUCTS THAT
MAKE CYCLING SAFE, FUNCTIONAL & FUN.**

CONTENTS

NEW PRODUCTS 2027	06
FOR GRAVEL BIKES	
CARRIERS & KICKSTANDS	09
FOR E-CARGO BIKES	12
MODULAR REAR CARRIERS	14
FOR E-BIKES	17
REAR CARRIERS	19
REAR CARRIERS: INTEGRATED TAILLIGHTS	21
FOR VARIOUS BICYCLES TYPES	
CARRIERS	
FRONT CARRIERS	24
REAR CARRIERS	27
SEATPOST-MOUNTED CARRIERS	31
CARRIER ACCESSORIES	32
KICKSTANDS	
CENTER-MOUNTED	35
REAR-MOUNTED	39
KICKSTAND TOP PLATES	41
BOTTLE CAGES & ADAPTERS	43
WORKSHOP, STANDS & STORAGE	46
BICYCLE HANGER & SHELVES	50
TRAINER & ACCESSORIES	53
OTHER ACCESSORIES	54

NEW PRODUCTS FOR 2027



City / Commuter

YFA-104A

Compact alloy handlebar basket

Fits 31.8mm handlebars

Perfect for short commutes & light daily essentials

Size: 315 x 240 x 75mm | Max. load: 5 kg



City / Commuter

YFA-113

Alloy front carrier with big plate

Unique stingray shape prevents hitting the bike frame while steering

Max. load: 10 kg



E-bikes / Gravel

YA-291GA

Adjustable light weight carrier

Max. load: 20 kg



Gravel / Racing

YA-319SF

Lightweight and adjustable.

Built-in plastic fender.

700C wheels

Max. load: 18 kg



Various bikes under 26" / Cargo bikes

WS-427A

Easylift heavy-duty bike stand

Efficient lifting: Lifts rear wheel with minimal effort

Universal compatibility: Fits various bicycle types under 26"

User-friendly: Supports bicycle without removing cargo

Foldable
For compact storage

Folds flat



All bikes, especially e-bikes

WS-421

Steel / alloy

Adjustable arms

Fits 20" - 29" tires with 23C - 3" | Extended type is available

Single arm design provide invisible support for bikes



E-Bikes / City / Commuter / MTB

YRA-60G

ADC10 with plastic

Adjustable: 24" - 29"

Max weight: 18 Kg



E-Bikes / City / Commuter / MTB

M-214

Bottle cage holder for handlebars

Material: Aluminium

For 31.8mm



E-bikes

M204

Battery handle bracket

For Bosch BT-800

Material: Plastic



Push Bikes / Bikes with alloy rims

WS-919C

Bicycle hook

Wall-mounted

Hanger can be rotated



PATENTED

WS-919B-03-01

Size including display: (H) 210 x (W) 60 x (D) 45 cm



E-bikes / City / Commuter / MTB

YRA-81G

ADC10 with 6061 alloy

Big angle to fit various bikes with disc brakes

Adjustable: 24" - 29"

Max weight: 25 kg



Folding bike

YRA-65M

Rear axle mounted kickstand

Material: alloy 6061, plastic

Adjustable: 16"-20"

Max weight: 18 kg



PATENTED

DIRECT MOUNT

40^{MM}

NO TOOLS NEEDED

NO TOOLS NEEDED

NO TOOLS NEEDED

NO TOOLS NEEDED

NO TOOLS NEEDED

NO TOOLS NEEDED

NO TOOLS NEEDED

NO TOOLS NEEDED

NO TOOLS NEEDED

NO TOOLS NEEDED

NO TOOLS NEEDED

NO TOOLS NEEDED

NO TOOLS NEEDED

NO TOOLS NEEDED

NO TOOLS NEEDED

For central motor type bikes

E-bikes

YRA-72G

ADC10 with plastic feet

Diameter: 40mm

Adjustable: 24"-29"

Max. weight: 30 kg



PATENTED

DIRECT MOUNT

40^{MM}

NO TOOLS NEEDED

NO TOOLS NEEDED

NO TOOLS NEEDED

NO TOOLS NEEDED

NO TOOLS NEEDED

NO TOOLS NEEDED

NO TOOLS NEEDED

NO TOOLS NEEDED

NO TOOLS NEEDED

NO TOOLS NEEDED

NO TOOLS NEEDED

NO TOOLS NEEDED

NO TOOLS NEEDED

NO TOOLS NEEDED

Chain stay sloping available

E-bikes / City / Commuter

YRA-77J (JD)

6061 alloy, anodized or ED black

Diameter: 40mm

Adjustable: 26"-29"

Max. weight: 50 Kg (Heavy loading)

GRAVEL BIKES | CARRIERS & KICKSTANDS



Gravel
YA-368
 Side mounting carrier for gravel bikes
 Material: Aluminium
 Adjustable, fits most bikes



Gravel / road
YA-319SF
 Lightweight and adjustable. Built-in plastic fender.
 700C wheels



PATENTED
 Gravel / City / Commuter
YA-269Q
 Rear carrier with side mounting system

Max. load: 18 kg

Max. load: 27 kg



Gravel / City
YFA-87A
 Alloy handlebar carrier
 Fits 31.8mm handlebar
 Max. load: 5 kg



PATENTED
DIRECT MOUNT
18 MM



For central motor type bikes

Gravel / Heavy-duty e-bikes
YRA-50D
 Bolt-on type, alloy
 Diameter: 18mm. Fits on chainstay / dropout
 Adjustable: 24" - 29"
 Max. weight: 35 kg



Gravel
M84C
 Side cage for gravel bikes
 For fork or carrier side mounting
 Material: Aluminium
 Max. load: 5 kg



M182
 Plastic
 Mounted on forks or frame tubes to allow installation of various accessories



E-CARGO BIKES | CARRIERS & KICKSTANDS

COMPLETE PARTS SOLUTION FOR YOUR E-CARGO BIKES: **FRONT CARRIERS, REAR CARRIERS AND KICKSTANDS.**

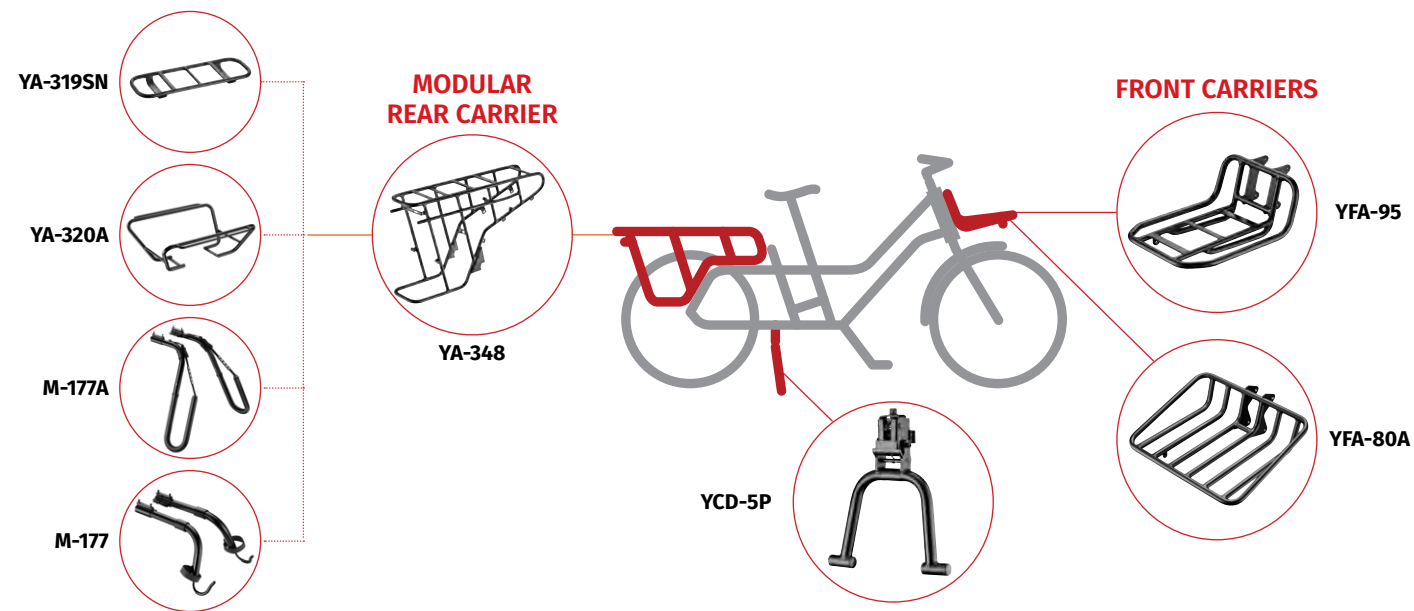

KICKSTANDS



E-Cargo bikes
YCD-5P
Steel double kickstand
Fits 3" width tire, suitable for heavy loads
Max. weight: 250 Kg

FRONT CARRIERS



E-Cargo bikes
YFA-95
Frame mounted front carrier, alloy tube with rigid design
Head tube fix design
Light bracket included
Fixing points can be customized
Size: 270mm x 340mm, Max. load: 10 Kg



E-Cargo bikes
YFA-80A
Frame mounted front carrier, alloy tube with rigid design
Top tube and down tube fix design
Light bracket included
Fixing points can be customized
Size: 360mm x 460mm, Max. load: 15 Kg



E-Cargo bikes
YA-348
Long tail rear carrier, alloy tube
Extended fix plate form
2X THULE yepp child seat, side plates available
Fixing points can be customized
Max. load: 54 Kg

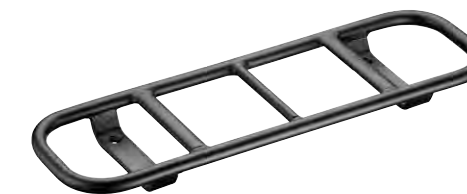

E-Cargo bikes
YA-319SN
Long tail rear carrier, alloy tube
Extended plate form for quick release (QR) . Compatible with: Racktime Snapit 2.0 system adapter and AtranVeloSystem
Bolt fix with carrier



KNOCKDOWN DESIGN
E-Cargo bikes
YA-320M
Universal baby seat rail + bag M194
Extra large bag frame
YA-320A
Universal baby seat rail only, no bag M194



E-Cargo bikes
M177
Pushbike holder
Carrier utility system
Foldable design
Max. load: 10 kg



E-Cargo bikes
M177A
Surfboard holder
Carrier utility system
Foldable design
Max. load: 10 kg



M194
Extra large bag for YA-320M universal baby seat rail
600D polyester / PVC anti-slip leather, water-resistant
Size (L / W / H): 57 x 28.5 x 34 cm
Capacity: 46000 ml Weight: 1200 grams

PATENTED
Introducing our **E-CARGO BIKE MODULAR REAR CARRIER.**

Customize and add functionality to your **YA-348** rear carrier with a variety of extensions quickly and conveniently.

1. Start with the **REAR CARRIER.**



YA-348
Extended fix plate form with fixing points.

2. Add **EXTENSIONS AND ACCESSORIES.**

3. Mix and match depending on your needs.

Learn how easy it is to add different extensions to the base rear carrier and maximize the utility of your cargo e-bike.

Scan to watch a short video:

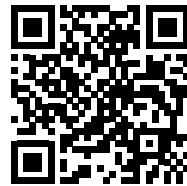

www.yueni.com.tw/video

USER PROFILE

The Shopper



QR system



ACCESSORY:
QR SYSTEM
Compatible with:
• Racktime Snapit 2.0
• AtranVeloSystem

EXTENSION:
YA-319SN
Extended platform for quick release.

REAR CARRIER:
YA-348



USER PROFILE

Young Child



EXTENSION:
YA-320A
Universal baby seat rail. Can also be adapted to carry cargo with the addition of a cargo bag.

REAR CARRIER:
YA-348



USER PROFILE

Cargo Handler

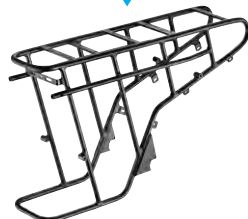
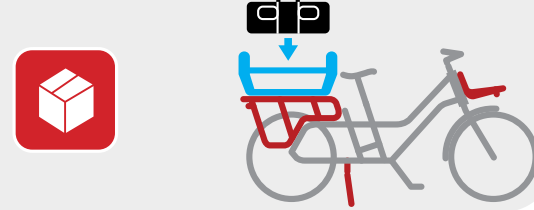

ACCESSORY:
M194
600D polyester / PVC extra large bag for YA320A

EXTENSION:
YA-320A
Universal baby seat rail can also be adapted to carry cargo with the addition of a cargo bag.

REAR CARRIER:
YA-348



USER PROFILE

The Surfer

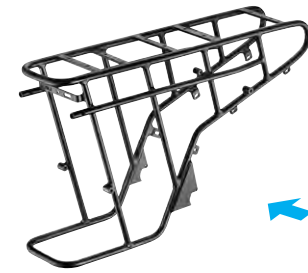
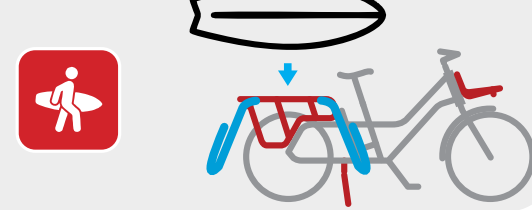

REAR CARRIER:
YA-348

EXTENSION:
M-177A
Surfboard hooks, with nylon straps and rubber scuff protectors.



USER PROFILE

The Pushbiker

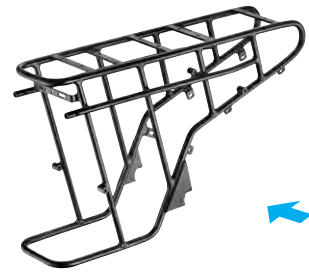
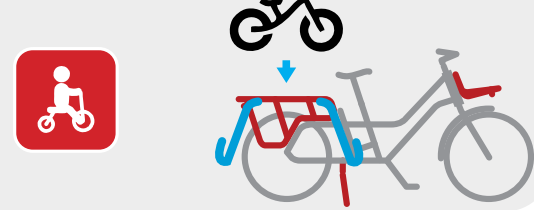

REAR CARRIER:
YA-348

EXTENSION:
M-177
Pushbike hooks, with nylon straps.





E-bikes / City / Commuter

YA-251B
Alloy tube frame and stays
Fender can be fixed on carrier

Max. load: 18 Kg



CUSTOMIZED CARRIER:
For reference / information purpose only
Full suspension e-bikes

YA-255A
Aluminum carrier
Snap-it, AVS quick-release system available
4-POINTS FIXED
Max. load: 20 Kg



Lightweight design
Made for use with panniers
E-bikes / Gravel

YA-267A
Carrier integrated with double-wall alloy fender

Max. load: 18 Kg



Compatible with AVS quick-release system
E-bikes / City / Commuter

YA-269B
Carrier integrated with alloy fender

Max. load: 25 kg



E-bikes / City / Commuter

YA-269C
Alloy tube frame and stays
Fits Thule Yepp baby seats
Fits: 24", 26", 27", 28"
Max. load: 30 kg



PATENTED
E-bikes / City / Commuter / Children

YA-269CA + YRD-7CD

Rear carrier: YA-269CA Aluminum carrier with kickstand	Kickstand: YRD-7CD Steel, Auto lock With lock and springs Fits 20", 24", 27"
--	--



CUSTOMIZED CARRIER:
For reference / information
purpose only

Full-suspension e-bikes

YA-275

Aluminum carrier

Fender can be fixed on carrier

3-POINTS FIXED

Max. load: 18 kg



E-bikes / City / Commuter

YA-277

Aluminum tube frame and stays

Fits Thule Yepp baby seats

Heavy duty, max. load: 30 kg



Lightweight design
Made for use with panniers

E-bikes / Gravel

YA-278A

Carrier integrated with double-wall alloy fender

Max. load: 20 kg



E-bikes for Shimano Steps

YA-246A

Alloy tubular

With side frame with pannier

Adjustable: 26" - 29"

Max. load: 25 kg



More info at:
www.lite-move.com

E-bikes / City / Commuter



YA-291A

With light integrated (**Litemove TA-KS tail lights**)

Compatible with SNAP-IT / AVS QR SYSTEM

Recommend: Double wall fender (not included)

Max. load: 20 kg



E-bikes / City / Commuter

YA-291C

With light integrated (**Dosun tail lights RX-N**)

Compatible with SNAP-IT / AVS QR SYSTEM

Recommend: Double wall fender (not included)

Max. load: 20 kg



Made for use with panniers

E-bikes / Gravel

YA-280A

Aluminum with integrated double wall fender

Fits 24", 26", 27", 28"

Max. load: 18 kg



Made for use with panniers

E-bikes / Gravel

YA-280B

Aluminum carrier

SNAP-IT QR SYSTEM

Fits 24", 26", 27", 28"

Max. load: 18 kg



E-bikes for Shimano Steps

YA-244C

Extra strong and durable

With clip

Max. load: 25 kg



Dosun RX-1
product detail:



E-bikes / City / Commuter

YA-291C-02-01

With light integrated (**Dosun RX-1 tail lights**)

Compatible with SNAP-IT / AVS QR SYSTEM

Recommend: Double wall fender (not included)

Max. load: 20 kg



E-bikes / City / Commuter

YA-291G

Integrated type carrier design to combine with alloy fender

Max. load: 20 kg



E-bikes / City / Commuter

YA-278D

With light integrated (**Roxim tail lights R7EA**)

Compatible with SNAP-IT / AVS QR SYSTEM

Recommend: Double wall fender (not included)

Max. load: 20 kg



E-bikes / City / Commuter / MTB

YCA-13G

ADC10 with plastic feet

New feet design for e-bike

Adjustable: 24" - 29"

Max. weight: 30 kg



Locking teeth ensures a secure, no-slip lock.

**SECURE LOCK DESIGN**

E-bikes / City / Commuter

YCA-13JC

Heavy-duty

Adjustable: 24" - 29"

Max. weight: 35 kg

**PATENTED**

E-bikes / City / Commuter

YCA-14

High-strength forged alloy

Fitted to chainstay neck

Adjustable, fits onto 29" bikes

Max. weight: 50 kg

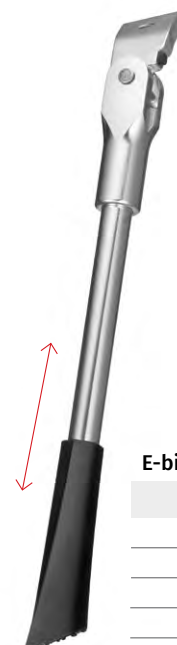

E-bikes / City / Commuter

YCA-18J

Alloy central kickstand

Fits 20", 24", 26", 27", 28", 29"

**DIRECT MOUNT**
40^{MM}

E-bikes

YRA-72A

Bolt-on type, alloy

Dia: 18mm. Fits chainstay / dropout

Fits 24", 26", 27", 28"

Max. weight: 30 kg

**DIRECT MOUNT**
40^{MM}

E-bikes / City / Commuter

YCA-72B

Bolt-on type, alloy

Dia: 18mm. Fits chainstay / dropout

Adjustable: 24"-29"

Max. weight: 35 kg

**PATENTED**
DIRECT MOUNT
40^{MM}**For central motor type bikes**

E-bikes

YRA-72G

ADC10 with plastic feet

Diameter: 40mm

Adjustable: 24"-29"

Max. weight: 30 kg

**PATENTED**
DIRECT MOUNT
18^{MM}**Chain stay sloping available**

E-bikes / City / Commuter

YRA-76J (JD)

6061 alloy, anodized or ED black

Diameter: 18mm

Adjustable: 26"-29"

Max. weight: 50 Kg (Heavy loading)

**DIRECT MOUNT**
18^{MM}**For central motor type bikes**

E-bikes / City / Commuter

YRA-50A

Bolt-on type, alloy

Dia: 18mm. Fits chainstay / dropout

Fits 24", 26", 27", 28"

Max. weight: 30 kg

**PATENTED**
DIRECT MOUNT
18^{MM}**For central motor type bikes**

E-bikes / City / Commuter

YRA-50D

Bolt-on type, alloy

Dia: 18mm. Fits chainstay / dropout

Adjustable: 24"-29"

Max. weight: 35 kg

**PATENTED**
DIRECT MOUNT
18^{MM}**For central motor type bikes**

E-bikes

YRA-50G

ADC10 with plastic feet

Diameter: 18mm

Adjustable: 24"-29"

Max. weight: 30 kg

**DIRECT MOUNT**
40^{MM}**Suitable for S-pedelecs**
For central motor type bikes

E-bikes

YRA-69

Forged body, bolt-on type

Diameter: 40mm

Adjustable: 24" - 28", 26" - 29"

Big angle design for more stability

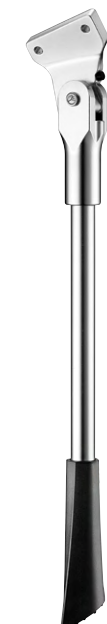
**PATENTED**
DIRECT MOUNT
40^{MM}**Chain stay sloping available**

E-bikes / City / Commuter

YRA-77J (JD)

6061 alloy, anodized or ED black

Diameter: 40mm

Adjustable: 26"-29"

Max. weight: 50 Kg (Heavy loading)

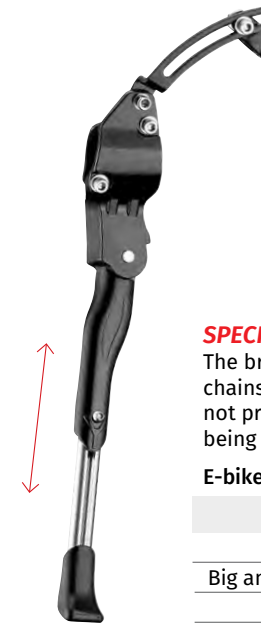
**SPECIALLY DESIGNED ANGLE**

The bracket can be retracted under the chainstays when it is kicked up and will not protrude, preventing your heels from being accidentally hit.

E-bikes / City / Commuter / MTB

YRA-81

ADC10 with plastic feet

Big angle to fit various bikes with disc brakes

Adjustable: 24"-29"

Max. weight: 18 kg

**SPECIALLY DESIGNED ANGLE**

The bracket can be retracted under the chainstays when it is kicked up and will not protrude, preventing your heels from being accidentally hit.

E-bikes / City / Commuter / MTB

YRA-81BA

ADC10 with plastic feet

Big angle to fit various bikes with disc brakes

Adjustable: 24"-29"

Max. weight: 25 kg

FOR VARIOUS BICYCLE TYPES



FRONT CARRIERS



Touring
YFA-14BA
 Low pannier rack
 V-brake pivot on suspension
 Front fork fitting, adjustable u-clamp
 Max. load: 18 kg



Touring
YFA-36A
 Low rider pannier rack
 Rigid fork fitting
 Max. load: 18 kg



City / Commuter sports
YFA-16B
 Alloy tube frame and wire stays
 Max. load: 10 kg



City / Commuter sports
YFA-17A
 Alloy tube frame and wire stays
 Longer extensions for more room
 Extensions can be placed on dropout / axle
 Can be used for briefcases and bags
 Max. load: 10 kg

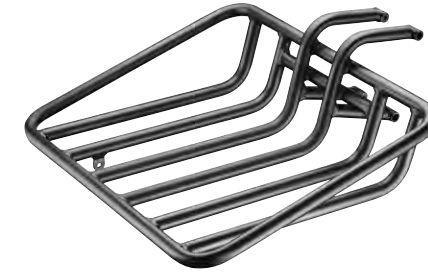

YFA-80
 Alloy tube with rigid design
 Top tube and down tube fixed design
 Light bracket included
 Fixing points can be customized
 Size: 360mm x 460mm, Max. load: 15 kg



Cargo bikes
YFA-104A
 Compact alloy handlebar basket
Fits 31.8mm handlebars
 Size: 315 x 240 x 75mm
 Perfect for short commutes & light daily essentials
 Max. load: 5 kg



Gravel / City
YFA-87A
 Alloy
 Fits 31.8mm handlebar
 Handlebar carrier
 Max. load: 5 kg



Cargo bikes
YBA-5
 Extension basket for carrier
 Material: Aluminium
For EUROBOX



YFA-113
 Alloy front carrier with big plate
 Unique stingray shape prevents hitting the bike frame while steering
 Max. load: 10 kg



YFS-21EA
 Steel wire frame and stays
 Fitted on fork pivots
 Fits: 24", 26", 27", 28"
 Max. load: 10 Kg



Cargo bikes
YFA-79
 Alloy tube with rigid design
 Head tube fix design
 Light bracket included
 Fixing points can be customized
 Size: 290mm x 310mm, Max. load: 10 kg



Cargo bikes
YFA-95
 Frame mounted front carrier
 Head tube fix design
 Fixing points can be customized
 Size: 270mm x 340mm
 Max. load: 10 kg



YFA-54B
 Alloy front basket carrier
 With wood plate and support extensions
 Max. load: 10 kg



YFK-23A
 Alloy basket for minivelo/city bike



YFK-26
 Alloy basket with wood plate for minivelo/city bike





REAR CARRIERS



City / Commuter
YA-7B
 Alloy diecast (ADC10) frame and steel wire stays
 With clip, foldable
 Adjustable brackets
 Fits: 24", 26", 27", 28"
 Max. load: 18 kg



City / Commuter
YA-16E
 Adjustable brackets
 Fits: 24", 26", 27", 28"



City / Commuter / Touring
YA-17JAC
 Alloy wire frame and stays
 Adjustable brackets
 Adjustable: 24" - 28"



City / Commuter / Children
YA-32LDA
 Alloy tube frame and stays
 With clip
 Fits: 24", 26", 27", 28"



City / Commuter / Touring
YA-66D
 Alloy wire frame and stays
 With clip
 Adjustable brackets
 Adjustable: 24" - 28"



City / Commuter
YA-73SEJA
 Square tube frame and stays
 With clip, foldable
 Adjustable: 24" - 28"



City / Commuter / Touring
YA-91J
 Alloy tube frame and stays
 With clip
 Adjustable stays and brackets
 Adjustable: 24" - 28"
 Max. load: 25 kg



City / Commuter
YA-157A
 Alloy tube frame and stays
 Adjustable stays and brackets
 Adjustable: 24" - 28"
 Max. load: 18 kg



For bikes with disc brakes

City / Commuter

YA-157CAJ

Alloy tube frame and stays

Adjustable brackets

Fits: 26", 27", 28"

Max. load: 18 kg



Touring

YA-161JD

Alloy tube frame and stays
With reflector bracket

Adjustable stays and brackets

Adjustable: 24" - 28"

Max. load: 25 kg



City / Commuter

YA-162A

Alloy tube frame and stays
With clip and reflector bracket

Fits: 20 - 22", 24" - 28"

Max. load: 18 kg



Touring

YA-169B

Alloy tube frame and stays

Adjustable brackets

Adjustable: 24" - 28"

Max. load: 25 kg



City / Commuter / Classic road

YA-247A

Lightweight alloy

Longer extension gives more room

Extension can be placed on dropout / axle

Max. load: 18 kg



City / Commuter / Touring

YA-248B

Adjustable brackets

Max. load: 25 kg



YA-269

Carrier with integrated fender

Fits: 24", 26", 27", 28"

Max. load: 25 kg



PATENTED

YA-269Q

Carrier with side mounting system

Max. load: 27 kg



City / Commuter

YA-193SA

Square tube frame and stays
With clip

Fits: 24", 26", 27", 28"

Max. load: 18 kg



City / Commuter

YA-212

Alloy wire frame and stays

Adjustable brackets

Fits: 24", 26", 27", 28"

Max. load: 18 kg



YA21809A adapter plate add-on for installation of QR bag, basket, etc.

City / Commuter

YA-218B

Alloy tube frame and stays
Foldable

Adjustable stays and brackets

Adjustable: 26" - 29"

Max. load: 18 kg



City / Commuter

YA-240

Lightweight alloy tubular
With bandage hook design

Adjustable brackets

Max. load: 18 kg



Cargo bikes

YA-312

Long tail alloy rear carrier
Extended fixed platform

Fixing points can be customized

2X THULE yepp child seat, side plates available



YA-320C

Universal baby seat rail
Knockdown design

Extra large bag frame



Gravel

YA-368

Side mounting carrier for gravel bikes
Material: Aluminium

Adjustable, fits most bikes



YA-291G

Alloy
Fender integrated light weight carrier
No fender included

Max. load: 20 kg

E-bikes / Gravel



YA-291GA

Adjustable light weight carrier

Max. load: 20 kg



Gravel / Road

YA-319SF

Lightweight and adjustable. Built-in plastic fender.
700C wheels

Max. load: 18 kg



City / Commuter

YS-11TDA

Stainless wire frame and stays
Foldable
Fits: 24", 26", 27"
Adjustable: 24" - 28"
Max. load: 18 kg



YS-23

Stainless wire frame and stays
Foldable
Fits: 24", 26", 27", 28"
Adjustable: 24" - 28"
Max. load: 18 kg



For bikes with cantilever brakes

City / Commuter

YS-41AEC

Stainless wire frame and stays
Fits: 24", 26", 27", 28"
Adjustable: 24" - 28"
Max. load: 18 kg



YA-111Q

Aluminium quick-release
Seatpost diameter range: 25.4mm - 35mm
Max. load: 10 Kg



YA-149QB

Aluminium quick-release
Seatpost diameter range: 25.4mm - 33mm
Max. load: 10 Kg

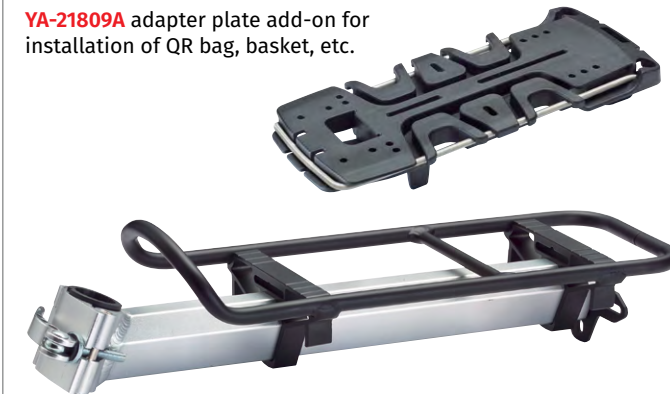

YA-21809A adapter plate add-on for installation of QR bag, basket, etc.

City / Commuter

YA-225

Aluminium
With extrusion quick-release buckle system
Seatpost diameter range: 25.4mm - 33mm
Max. load: 10 Kg

CARRIER ACCESSORIES



M84A
Alloy gravel cage
For fork or carrier side mounting
Max. load: 5 kg



M-41A
Extension bracket
Fitted on front / rear carrier stays (7.8mm-14mm)
Default extension bracket tube size is 22mm



M182
Plastic
Mounted on forks or frame tubes to allow installation of various accessories



YC-1
Detachable bike clip clamp
Standard size for plastic joints: 8mm

01 CARRIER ACCESSORIES | FITTING SETS

 F1 Horizontal type	 F2 Descending type	 F4 Horizontal type	 F4C	 F6	 F9G	 F12
 F12BB	 F15B	 F17	 F17A	 F17B	 F17C	 F22



YI-3
Three-strip strap
Steel wire hook with PVC coating



YI-4
Elastic strap with leather



YI-7A
Elastic two-strip strap with leather



KICKSTANDS | CENTER-MOUNTED

3 TYPES OF KICKSTAND ADJUSTMENTS

Every process is made in-house using our own facilities and personnel so we can control the quality and schedule. You do not have to go to other factories to finish your product. This greatly enhances production efficiency.

1. CLIP-TYPE ADJUSTMENT SYSTEM

Fast and convenient adjustment with just a clip-type interface. No tools needed.



Look for this logo for kickstands with the clip adjustment.

2. PIN-TYPE ADJUSTMENT SYSTEM

A simple pin system allows you to quickly adjust your kickstand. A proven problem-free mechanism.

3. FIXED SYSTEM

No adjustment possible. The fixed system is the simplest and most robust form of kickstand able to withstand rough use.

Heavy-duty construction ensures years of trouble-free and reliable service.



E-bikes/ City / Commuter / Touring
YCD-37A
 Electric control secureease kickstand steel
 Max. load: 150 kg

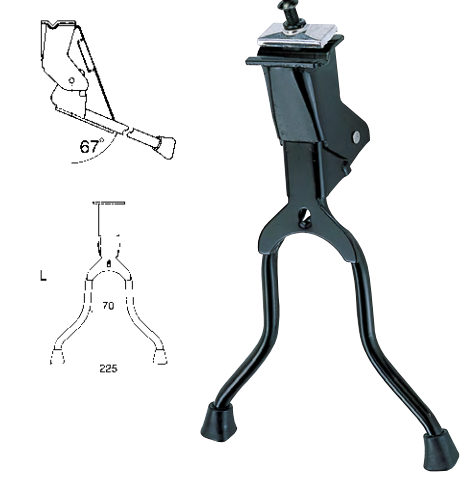

E-bikes/ City / Commuter / Touring
YCD-3
 Steel mounting seat, steel tube stays



E-bikes/ City / Commuter / Touring
YCD-3A
 Steel mounting seat, steel tube stays
 With big pads

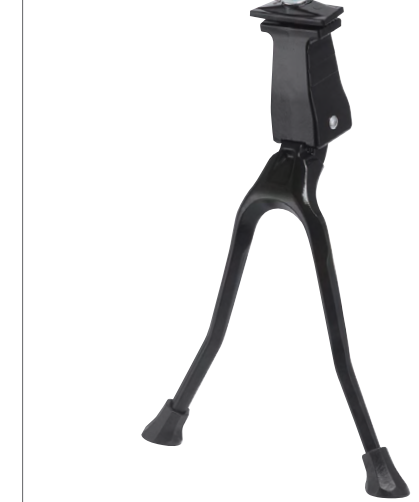

City / Commuter
YCD-20
 Fully diecasted alloy head and stays



Cargo bike / Heavy duty
YCD-5P
 Steel double kickstand
 its 3"width tire, suitable for heavy loads
 Max. weight: 250 kg



City / Commuter
YCA-1
 Light alloy
 Fitted to chainstay neck
 Fits 20", 22", 24", 26", 27", 28"



City / Commuter
YCA-1A
 Light alloy
 Fitted to chainstay neck
 Fits 20", 22", 24", 26", 27", 28"



City / Commuter / Touring
YCA-6A
 Light alloy
 Fitted to chainstay neck
 Fits 20", 22", 24", 26", 27", 28"



City / Commuter / Children
YCA-7
 High-strength alloy
 Fitted to chainstay neck
 Fits 20", 22", 24", 26", 27", 28"



City / Commuter / Children
YCA-8
 Light alloy
 Fitted to chainstay neck
 Fits 20", 22", 24", 26", 27", 28"



PATENTED
 City / Commuter / Touring
YCA-9
 Alloy
 Adjustable: 20"-24", 24"-28", 26"-29"



E-Bikes / City / Commuter / MTB
YCA-13G
 ADC10 with plastic feet
 New feet design for e-bike
 Adjustable: 24" - 29"
 Max. weight: 30 kg



City / Commuter
YCA-13JC
 Heavy-duty
 Fitted to chainstay neck
 Adjustable: 24" - 29"



City / Commuter / Children
YCA-5
 Light alloy
 Fitted to chainstay neck
 Adjustable: 24" - 28"



City / Commuter / Children
YCA-5I
 Light alloy
 Fitted to chainstay neck
 Adjustable: 16" - 24"



City / Commuter / Children
YCA-5A
 Light alloy
 Fitted to chainstay neck
 Adjustable: 24" - 28"
 With big foot



City / Commuter
YCA-5M
 Light alloy
 Fitted to chainstay neck
 Fits 22", 24", 26", 27", 28"



PATENTED
 City / Commuter / Fat bikes
YCA-15
 Alloy
 Fitted to chainstay neck
 Adjustable: 24" - 28", 26" - 29"



PATENTED
 City / Commuter / Fat Bikes / Children
YCA-15I
 ADC10 with plastic feet
 Big angle to fit various bikes with disc brakes
 Adjustable: 16" - 20", 20" - 24"



City / Commuter
YCA-16
 Plastic head with alloy stays
 Fitted to chainstay neck



KICKSTANDS | REAR-MOUNTED



Children / BMX / Folding
YRA-3
Light alloy
Fitted to chainstay neck
Adjustable: 24" - 28"

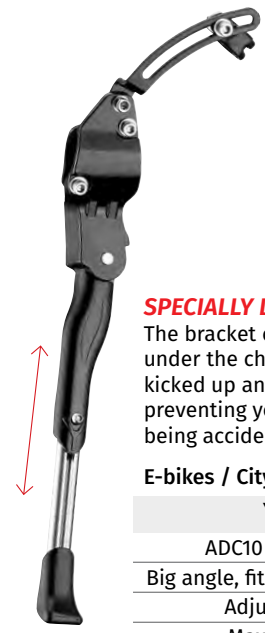

SPECIALLY DESIGNED ANGLE
The bracket can be retracted under the chainstays when it is kicked up and will not protrude, preventing your heels from being accidentally hit.
E-bikes / City / Commuter / MTB
YRA-81
ADC10 with plastic feet
Big angle, fit bikes with disc brakes
Adjustable: 24" - 29"
Max. weight: 18 kg



SPECIALLY DESIGNED ANGLE
The bracket can be retracted under the chainstays when it is kicked up and will not protrude, preventing your heels from being accidentally hit.
E-bikes / City / Commuter / MTB
YRA-81BA
ADC10 with plastic feet
Big angle, fit bikes with disc brakes
Adjustable: 24" - 29"
Max. weight: 25 kg

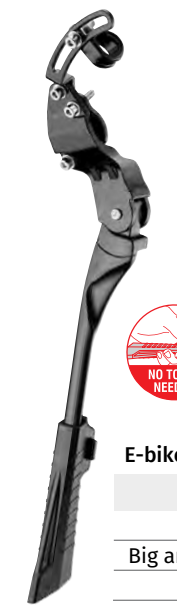

E-bikes / City / Commuter / MTB
YRA-81G
ADC10 with 6061 alloy
Big angle, fit bikes with disc brakes
Adjustable: 24" - 29"
Max weight: 25 kg



City / Commuter / MTB
YRA-9A
Alloy
For square stays
Adjustable: 24" - 28"



For central motor type bikes
City / Commuter / MTB
YRA-18
Alloy
Adjustable: 24" - 28"



YRA-36AK
YRA-36AKN
Rubber pads
PATENTED
City / Commuter / MTB
YRA-36AK | YRA-36AKN
Alloy with rubber pad or round and square tubes
Adjustable: 26" - 28"
Adjustable bracket fits various angles between seat and chain stays
Brake arm clip fits ø16, ø20, ø22 tubes



YRA-36AH
YRA-36AHN
PATENTED **For bikes with disc brakes**
City / Commuter / MTB
YRA-36AH | YRA-36AHN
Alloy with rubber pad
For round tubes
Adjustable: 26" - 28"
Extra long bracket for disc brake bikes



Children
YRA-54L
 Alloy
 Adjustable: 14" - 18"
 For small-wheeled bikes



City / Commuter
YRA-60
 Fitted to chainstay with screws
 Adjustable: 24" - 28", 26" - 29"

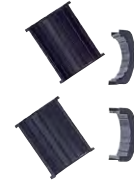

2 sets plastic parts for oval tube: Fits 27mm x 15mm - 21mm ; Square tube: Fits 25mm x 15mm - 21mm



City / Commuter
YRA-60B
 Fitted to chainstay with screws
 Quick adjusting mechanism

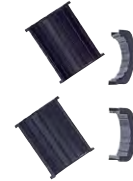

E-bikes / City / Commuter / MTB
YRA-60G
 Rear axle mounted kickstand
 Adjustable: 24" - 29"
 ADC10 with plastic
 Max weight: 18 kg

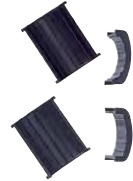

BMX / Folding / Children
YRS-10
 Steel
 Fitted on hub spindle
 Fits 16", 18", 20"



City / Commuter / MTB / Road
YRS-17J
 Steel
 Fitted on chainstay
 Adjustable: 24" - 28"



City / Commuter / MTB
YRS-18
 Steel tube
 Adjustable: 24", 26", 27", 28"



City / Commuter / MTB
YRS-23
 Steel
 Fitted to seat stay and chainstay
 Adjustable: 24", 26", 27", 28"



Road
YRA-65E
 Full extrusion
 Adjustable fitting arm for seat stay
 Fits on seat and chain stay with adjustable bracket
 Adjustable: 26" - 28"



For bikes with disc brakes
 24" / 26" / 700C
YRA-65H
 Light alloy
 Adjustable fitting arm for seat stay
 Fits on seat and chain stay with adjustable bracket
 Adjustable: 24" - 28"



E-bikes / City / Commuter / MTB
YRA-65M
 Rear axle mounted kickstand
 Material: alloy 6061, plastic
 Adjustable: 16" - 20"
 Max weight: 18 kg



City / Commuter / Children
YRD-7CA
 Steel, auto-lock
 With lock and springs
 Fits 24", 26", 27", 28"

KICKSTANDS | TOP PLATES



Y10B
 Alloy



Y17
 Alloy



Y4
 Alloy



Y3
 Steel



Y1
 Steel



YCH-1A
 Alloy



YCH-1
 Steel



YAB-1
Light alloy



YAB-1A
Alloy

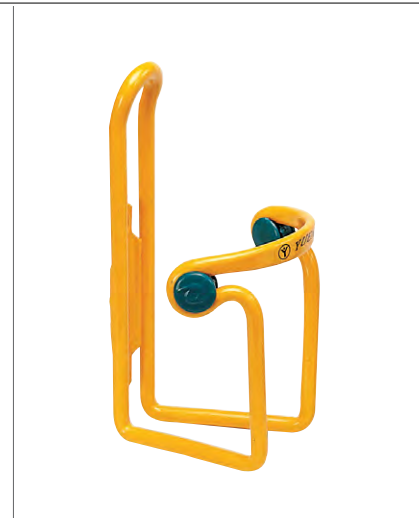

YAB-3
Alloy



YAB-16
Alloy



YAB-17
Alloy



YAB-24C
Light alloy
Fits PET, water bottles and others



PATENTED
YAB-25
Alloy
With laser-etched pattern
Weight: 38 grams

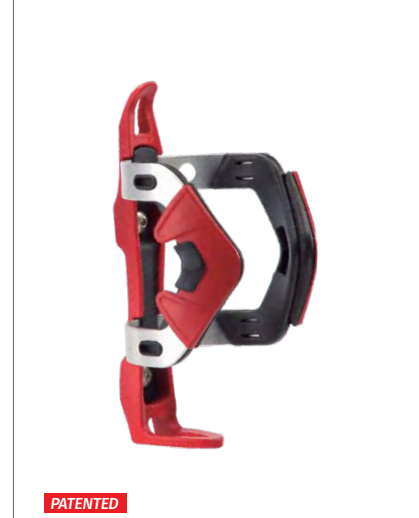

PATENTED
YAB-28
Alloy
Adjustable 3-position bottle shifting:
right, central, left side bottle removal
Plastic pads to fit various bottle sizes

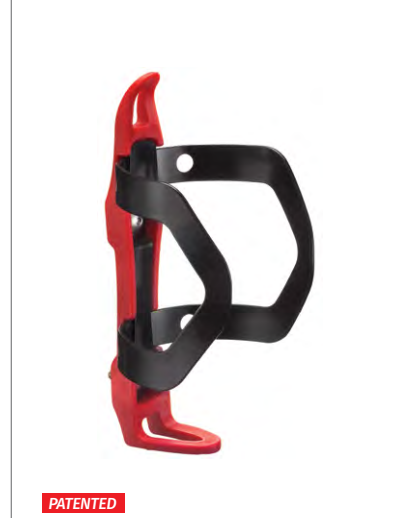

PATENTED
YAB-28A
Alloy
Adjustable 3-position bottle shifting:
right, central, left side bottle removal



PATENTED
YAB-29
Alloy plate
With laser-etched pattern
Weight: 32 grams



YAB-31
Alloy



YAB-33
Alloy with composite adjustment system
Fits diameter: 54mm - 74mm bottles
4-point front fixing for secure bottle retention and easy removal



Adjustable height, secure and quick neck fixing of PET bottles

YAB-12A
Alloy
Fits standard beverage cans and PET bottles
Allows bottles to be taken out easily



PATENTED

YAB-34
Composite

Weight: 37 grams



YSB-1
Light steel

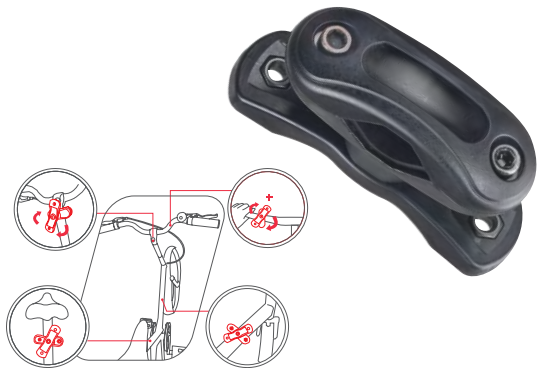

PATENTED

M-38

Multi-function turning adapter
For 22mm - 36mm tubes

Fits on handlebars and bike frames and seat post, turns to 24 angles



PATENTED

M-25

Fixes on the bicycle frame's bottle cage holes
Allows re-position of bottle cage holes
Adjustment: 45mm up / 45mm down
Weight: 29 grams



E-Bikes / City / Commuter / MTB

M-214

Bottle cage holder for handlebars
Material: Aluminium
For 31.8mm



WORKSHOP, STANDS & STORAGE



WS-101A

Bike carrier adapter with telescopic extension up to 65mm
For Y-frame



WS-403

Mounted on seat and chain stays
Powder-coated
Color: Black, white



WS-403B

Easy to adjust angle via hooks to fit various bikes



PATENTED

WS-403C

Maintenance stand with foldable base

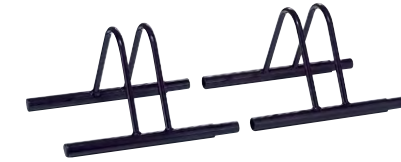

WS-415D

Parking stand
Can be extended by connecting several units together



PATENTED

WS-416JC

Enhanced "L" shaped steel
Spring mechanism auto-slide and lock
For 20" to 29" bikes

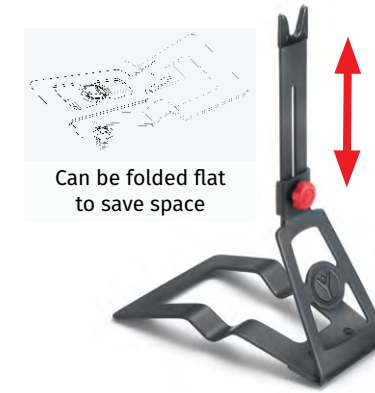

Can be folded flat to save space

PATENTED

WS-416JQ

Knockdown design
Spring mechanism auto-slide and lock
Small package, suited for online selling
Enhanced "L" shaped steel
For 20" to 29" bikes



PATENTED

WS-420

Foldable parking stand
Roller with spring tension allows a smoother and easier folding and unfolding
For 20" - 29" bicycles, 23mm - 3" tires



WS-405

Color: Black



PATENTED DESIGN FOR SELECTED LEVER MODELS



TYPE A
For standard levers

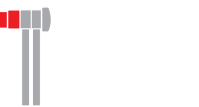

TYPE B
For Mavic and classic levers

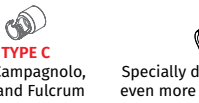

TYPE C
For Campagnolo, FSA and Fulcrum levers



Specially designed to fit an even more extensive line of skewer quick-release lever types and thru-axles

PATENTED

WS-406D

Suitable for bicycles with wheel size under 29", patented design that allows easy fitting of skewer quick release levers, extra clamp length for easier derailleur adjustment



WS-406C

Open design allows cleaning and maintenance of the cassette when installed

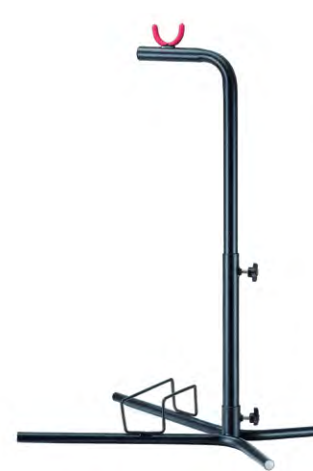

WS-412

Outstanding stability when installed suitable for high-traffic areas

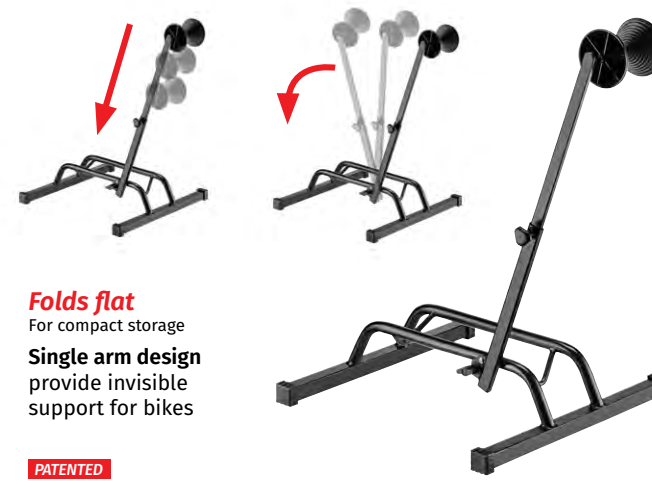

Folds flat
For compact storage
Single arm design
provide invisible support for bikes

PATENTED

WS-421

Steel / alloy
For all bike, especially e-bikes
Adjustable arms
Fits 20" - 29" tires with 23C - 3"
Extended type is available



Various bikes under 26" / Cargo bikes

WS-427

Easylift heavy-duty bike stand
Efficient lifting: Lifts rear wheel with minimal effort
Knockdown design: Easily disassembled for transport and storage
Universal compatibility: Fits under 26"
User-friendly: Supports bicycle without removing cargo



Various bikes under 26" / Cargo bikes

WS-427A

Easylift heavy-duty bike stand
Efficient lifting: Lifts rear wheel with minimal effort
Universal compatibility: Fits under 26"
User-friendly: Supports bicycle without removing cargo



WS-501A

Wheel truing stand for all wheel sizes
Foldable, compact, portable and lightweight
With tire fixation



PATENTED

WS-502

Alloy wheel truing stand. Foldable and portable
Fits all wheel sizes and width
Up to 29" wheels and fat tires
Adjustable caliper trues disc rotors and rims



WS-911A

Foldable single bicycle hook
Wall-mounted



Push bikes / Bikes with alloy rims

WS-919C

Bicycle hook
Wall-mounted
Hanger can be rotated

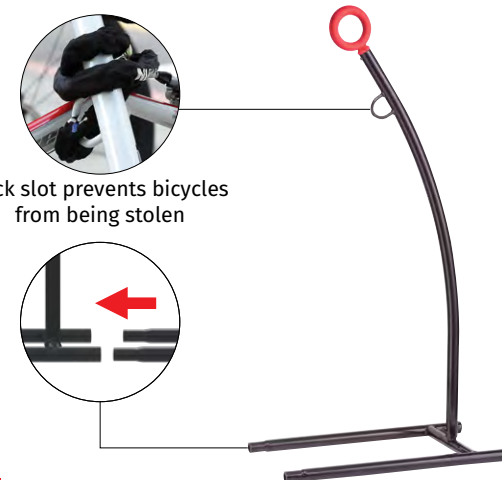

PATENTED

WS-610A

Multi-park module
Unlimited number of attachments
Excellent stability



PATENTED

WS-612

Speedy parking stand with knockdown design
Heavy duty, 25 kgs max. load
Fits up to 29" or 12" - 20" bikes
Hanger for helmets or clothes

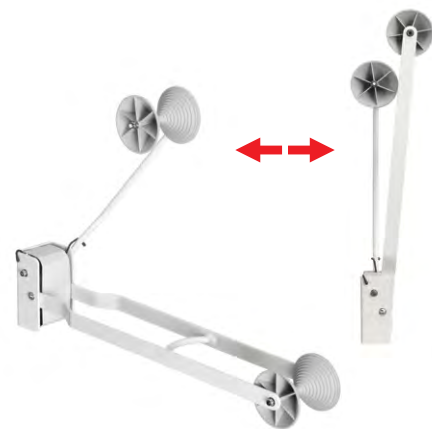

PATENTED

WS-918A

Foldable bicycle wall hanger
Roller with spring tension allows a smoother, easier
and more stable bike wall mounting and retrieval
For 20" - 29" bicycles, 23mm - 3" tires



M80A

Front fork holder
5mm, 12mm and 15mm thru-axle



M81A

Secures the stem and handlebar to a fixed position
For bicycle parking and display purposes



YSS-4

Safety handle for children's bikes

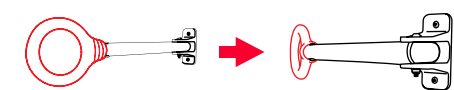

Foldable

PATENTED

WS-610W



PATENTED

WS-610WA

Wall-mounted, compact design perfect for indoor and
outdoor spaces

BICYCLE HANGER & SHELVES

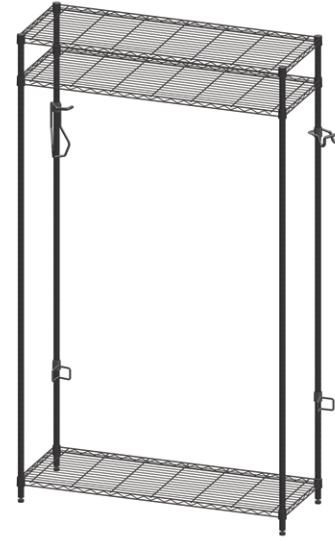

PATENTED

WS-919BB-03-01

Size including display: (H) 210 x (W) 120 x (D) 45 cm



PATENTED

WS-919B-03-01

Size including display: (H) 210 x (W) 60 x (D) 45 cm



EASYFIT DESIGN

Easily remove or install hook without needing to disassemble or uninstall any part of the display.



PATENTED

NO DRILLING REQUIRED

Push bikes / Bikes with alloy rims

WS-919-05-01

Sidekick. Rim type bike hanger for shelf stand
 Keep your rack intact, just add on
 No need to remove shelf when installing
 Patented design hanger allows hanging via front wheel on shelf
 Height and angle adjustable
 Fits 1" tubes
 Max. load: 15 Kg



WS-919-03-01

Wave-shaped shelf bike hanger
 Hangs bike via the front wheel
 Best for push bikes and bikes with alloy rims



WS-919-01-01

Thru axle bike hanger
 Patented design hangs bike via the front thru axle, which is the optimal solution for carbon fiber bikes and wheels





Easy adjustment with quick release

Locks securely

Protects your bike's paint

Beautifully designed and finished extensions

Excellent stability

PATENTED

WS-607

Height: 1.9 meters - 3.5 meters
 Easy installation in a few minutes
 Adjustable hanger
 Load weight limit: 72 Kg or around 4 bicycles



PATENTED

WS-607GA

Similar to the WS-607, except this is the self-standing type
 Heavy-duty base for exceptional stability



WS-607WB

Wall-mounted
 Load weight limit: 18 kg

INDOOR TRAINERS & ACCESSORIES



Single quick-release lever
 Allows the trainer to be set and released very quickly.



812B CORSO

Wire control system
 Loading weight limit: 100 kg



Compact and foldable
 Folded Size: 430mm x 600mm x 150mm
 The trainer can be stored vertically for a smaller footprint









150mm

The axle bearing is set up in front of the back wheel
 This is very close to the position of the crank, which means it prevents accidental touching during use.

Magnetic controlling box design
 Covers the entire magnetic system to prevent objects from entering the system.

			
YDP-1	YDP-2	YDP-3	YDP-4
			
YDP-5C	YDP-6	YDP-7	YDP-8
			
YDP-8D	YDP-9	YDP-10A	YDP-17C
			
YDP-22	YDP-23	YAP-14	YAP-16





					
A1	A2 Ø 15 steel	A3 Ø 22	A4 Ø 16	A5 Ø 25.4	A6 Ø 20

		
A10 Plastic Extension clip for tube 10mm	A10A Plastic Extension clip for tube 14mm	

ACCESSORIES | BASKET BRACKETS & SUPPORTS

	E-bikes
	M204 Battery handle bracket For Bosch BT-800 Material: Plastic

ACCESSORIES | BASKET BRACKETS & SUPPORTS

				
YB-1 Brackets for front basket Steel, stainless or alloy	YB-3 Brackets for front basket Steel, stainless or alloy	YB-4 Brackets for front basket Steel, stainless or alloy	YB-4J Brackets for front basket Steel, stainless or alloy Adjustable	YFK-0102 Basket supporters Steel, stainless or alloy Size: 20", 24", 26", 28"



YUEN I

YUEN I INDUSTRIAL CO., LTD.
元 毅 工 業 股 份 有 限 公 司

HEAD OFFICE

No. 16, Fu Kung Road, Fu Hsing Hsiang,
Changhua, Taiwan, R.O.C. 50662
彰化縣福興鄉福工路16號

TEL

+886 4 769 7615-7 / +886 4 769 2685 / +886 4 769 9033

FAX

+886 4 769 4315 / +886 4 769 8571

E-MAIL

service@yueni.com.tw

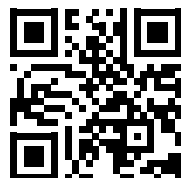

WWW.YUENI.COM.TW